

| Codice | Applicazione | d | D | A | B |
|--------------|--------------|------|-------|------|------|
| 59000 | Caterpillar | 25,0 | 76,0 | 17,0 | 25,5 |
| 59001 | Caterpillar | 35,0 | 101,5 | 23,8 | 28,6 |
| 59003 | Caterpillar | 45,0 | 127,0 | 25,0 | 31,5 |
| 59004 | Caterpillar | 45,0 | 127,5 | 25,0 | 31,8 |

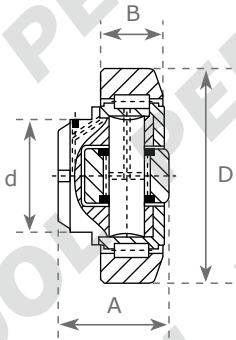

| Codice | Applicazione | d | D | B | A |
|--------------|--------------|------|------|------|------|
| 59102 | Cesab | 30,0 | 70,5 | 24,0 | 42,8 |
| 59101 | Cesab | 40,0 | 77,8 | 24,0 | 45,5 |

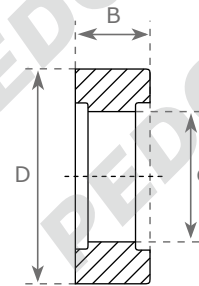

| Codice | Applicazione | d | D | B |
|--------------|--------------|------|-------|------|
| 59109 | Cesab | 73,0 | 111,3 | 36,0 |

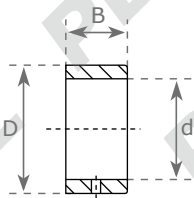

| Codice | Applicazione | d | D | B |
|--------------|--------------|------|------|------|
| 59110 | Cesab | 35,0 | 42,0 | 18,0 |
| 59111 | Cesab | 43,0 | 50,0 | 19,8 |
| 59112 | Cesab | 57,0 | 65,0 | 26,8 |

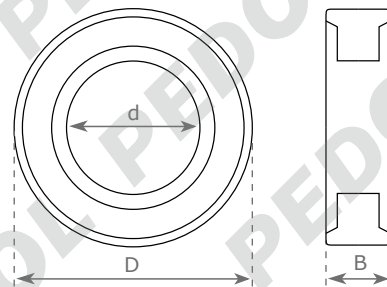

| Codice | Applicazione | d | D | B |
|--------------|--------------|------|------|------|
| 63641 | Cesab | 45,0 | 80,5 | 25,0 |
| 63642 | Cesab | 45,0 | 81,7 | 25,0 |
| 63654 | Cesab | 35,0 | 60,5 | 22,0 |

Quote espresse in mm

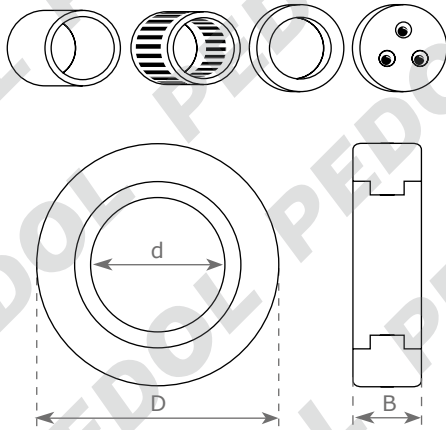

| Codice | Applicazione | d | D | B |
|--------------|-------------------------|------|------|------|
| 16689 | Cesab rullo montante | 58,0 | 92,0 | 28,0 |
| 16690 | Cesab anello interno | 43,0 | 50,0 | 20,0 |
| 16681 | Cesab gabbia a rulli | 50,0 | 58,0 | 20,0 |
| 16691 | Cesab rasamento interno | | | |
| 16692 | Cesab rasamento esterno | | | |

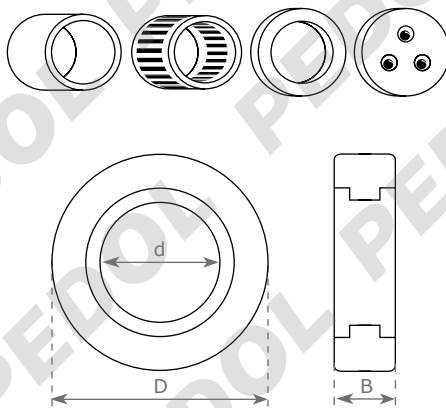

| Codice | Applicazione | d | D | B |
|--------------|-------------------------|------|------|------|
| 16693 | Cesab rullo montante | 32,0 | 50,0 | 25,0 |
| 16694 | Cesab anello interno | 20,0 | 25,0 | 16,0 |
| 16682 | Cesab gabbia a rulli | 25,0 | 32,0 | 16,0 |
| 16695 | Cesab rasamento interno | | | |
| 16696 | Cesab rasamento esterno | | | |

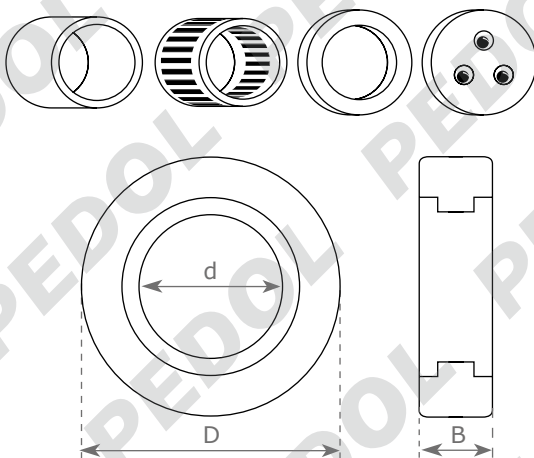

| Codice | Applicazione | d | D | B |
|--------------|-------------------------|------|-------|------|
| 16687 | Cesab rullo montante | 68,0 | 111,0 | 37,0 |
| 16685 | Cesab anello interno | 50,0 | 60,0 | 22,0 |
| 63531 | Cesab gabbia a rulli | 62,0 | 68,0 | 22,0 |
| 16686 | Cesab rasamento interno | | | |
| 16688 | Cesab rasamento esterno | | | |

Quote espresse in mm

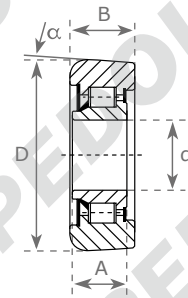
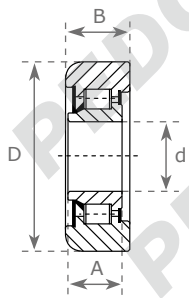

| Codice | Applicazione | d | D | A | B |
|--------------|--------------|------|------|------|------|
| 59251 | Clark | 25,0 | 76,1 | 20,7 | 25,4 |
| 59252 | Clark | 30,0 | 88,9 | 19,0 | 25,0 |

| Codice | App. | d | D | A | B | α |
|--------------|-------|------|-------|------|------|----------|
| 59253 | Clark | 35,0 | 101,5 | 23,8 | 28,6 | 1,5° |
| 59256 | Clark | 40,0 | 113,0 | 26,8 | 31,6 | |
| 59257 | Clark | 45,0 | 128,0 | 27,9 | 31,8 | |

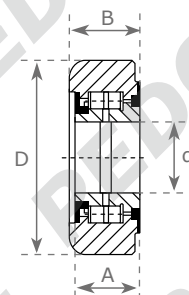
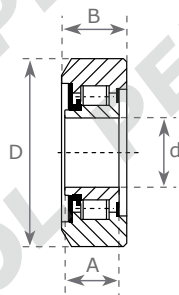

| Codice | Applicazione | d | D | A | B |
|--------------|--------------|------|-------|------|------|
| 59261 | Clark | 45,0 | 127,0 | 25,0 | 31,5 |

| Codice | Applicazione | d | D | A | B |
|--------------|--------------|------|-------|------|------|
| 59262 | Clark | 55,0 | 163,5 | 49,5 | 54,0 |

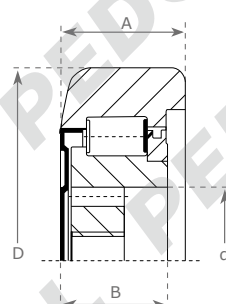
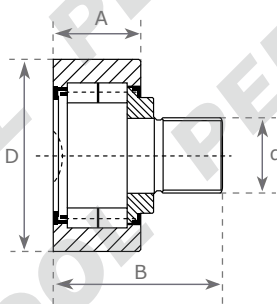

| Codice | Applicazione | d | D | A | B |
|--------------|--------------|------------|------|------|------|
| 59264 | Clark | 1" 1/4 UNF | 82,2 | 25,4 | 65,0 |

| Codice | Applicazione | d | D | A | B |
|--------------|--------------|------|------|------|------|
| 59290 | Detas | 36,0 | 90,5 | 29,0 | 25,0 |

Quote espresse in mm

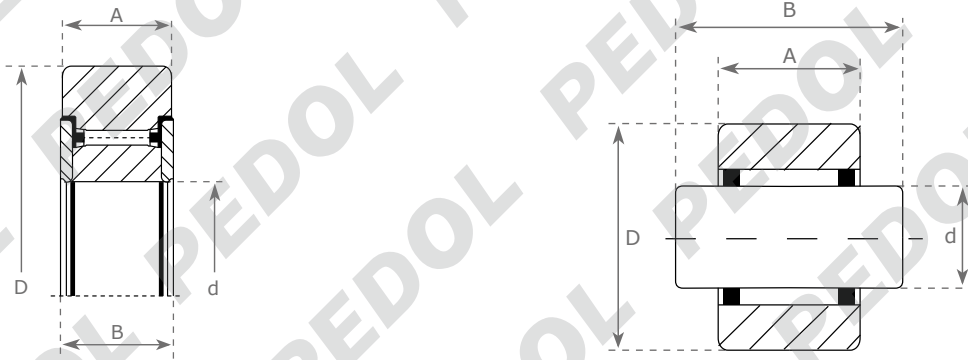

| Codice | Applicazione | d | D | A | B |
|--------------|--------------|------|------|------|------|
| 59291 | Detas | 45,0 | 80,0 | 21,0 | 22,0 |

| Codice | Applicazione | d | D | A | B |
|--------------|--------------|------|------|------|------|
| 59292 | Detas | 14,0 | 28,0 | 18,0 | 30,0 |

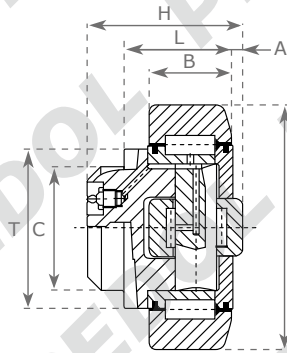

| Codice | Applicazione | A | B | C | D | H | L | T |
|--------------|--------------|-----|------|------|------|------|------|------|
| 59296 | Detas | 4,0 | 30,0 | 45,0 | 89,2 | 57,0 | 40,0 | 60,0 |

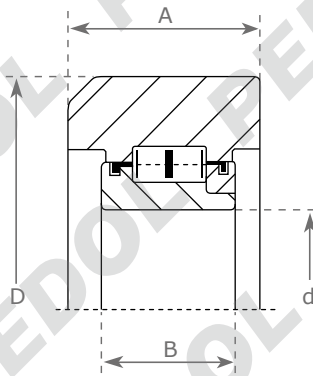

| Codice | Applicazione | d | D | A | B |
|--------------|--------------|------|-------|-------|------|
| 59350 | Hyster | 30,0 | 79,5 | 28,55 | 16,0 |
| 59352 | Hyster | 30,0 | 86,0 | 28,5 | 16,6 |
| 59357 | Hyster | 40,0 | 103,5 | 45,0 | 30,1 |

Quote espresse in mm

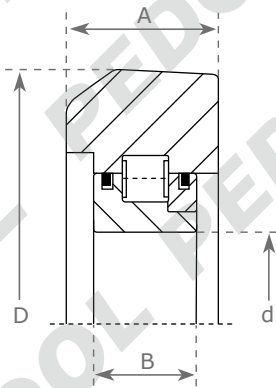

| Codice | Applicazione | d | D | A | B |
|--------------|--------------|------|-------|-------|------|
| 59353 | Hyster | 35,0 | 91,2 | 31,85 | 20,0 |
| 59354 | Hyster | 32,0 | 91,2 | 32,0 | 20,0 |
| 59355 | Hyster | 28,5 | 101,5 | 28,5 | 21,0 |
| 59359 | Hyster | 35,0 | 111,0 | 30,0 | 20,0 |

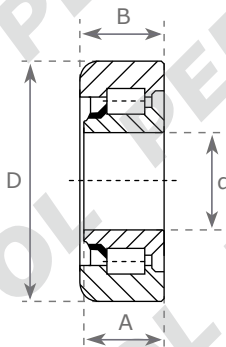

| Codice | Applicazione | d | D | A | B |
|--------------|--------------|------|------|------|------|
| 59478 | Linde | 30,0 | 75,3 | 24,0 | 24,0 |
| 59477 | Linde | 30,0 | 75,6 | 24,0 | 24,0 |
| 59479 | Linde | 30,0 | 75,9 | 24,0 | 24,0 |
| 59480 | Linde | 35,0 | 80,9 | 26,0 | 26,0 |
| 59481 | Linde | 35,0 | 81,2 | 26,0 | 26,0 |
| 59482 | Linde | 35,0 | 81,5 | 26,0 | 26,0 |

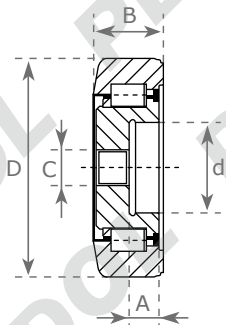

| Codice | Applicazione | d | D | A | B | C |
|--------------|--------------|------|------|------|------|-----|
| 59450 | Linde | 30,0 | 75,0 | 10,0 | 24,0 | M12 |
| 59451 | Linde | 30,0 | 76,0 | 10,0 | 24,0 | |

Quote espresse in mm

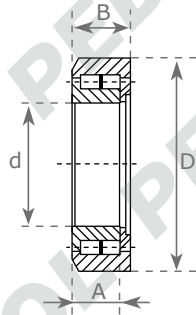

| Codice | Applicazione | d | D | A | B |
|--------------|--------------|------|-------|------|------|
| 59449 | Linde | 65,0 | 135,1 | 34,0 | 42,0 |
| 59475 | Linde | 65,0 | 135,6 | 34,0 | 42,0 |
| 59474 | Linde | 65,0 | 136,1 | 34,0 | 42,0 |
| 59453 | Linde | 75,0 | 129,3 | 30,0 | 34,0 |
| 59454 | Linde | 75,0 | 130,0 | 30,0 | 34,0 |

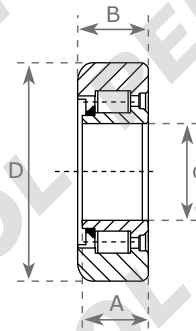

| Codice | Applicazione | d | D | A | B |
|--------------|--------------|------|------|------|------|
| 59455 | Linde | 40,1 | 89,9 | 27,0 | 29,0 |
| 59456 | Linde | 40,1 | 90,2 | 27,0 | 29,0 |
| 59457 | Linde | 40,1 | 90,5 | 27,0 | 29,0 |

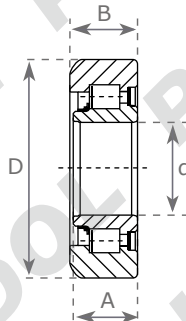

| Codice | Applicazione | d | D | A | B |
|--------------|--------------|------|-------|------|------|
| 59458 | Linde | 40,0 | 89,9 | 27,0 | 29,0 |
| 59459 | Linde | 40,0 | 90,2 | 27,0 | 29,0 |
| 59476 | Linde | 40,0 | 90,5 | 27,0 | 29,0 |
| 59473 | Linde | 45,0 | 105,4 | 32,0 | 34,0 |
| 59460 | Linde | 45,0 | 105,8 | 32,0 | 34,0 |
| 59461 | Linde | 45,0 | 106,1 | 32,0 | 34,0 |

Quote espresse in mm

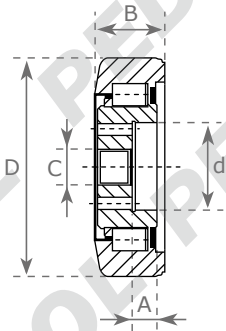

| Codice | App. | d | D | A | B | C |
|--------------|-------|------|-------|------|------|-----|
| 59462 | Linde | 36,0 | 89,5 | 10,0 | 29,0 | M16 |
| 59452 | Linde | 36,0 | 90,5 | 10,0 | 29,0 | |
| 59464 | Linde | 42,0 | 105,0 | 9,5 | 34,0 | M20 |
| 59465 | Linde | 42,0 | 105,7 | 9,5 | 34,0 | |
| 59466 | Linde | 42,0 | 106,5 | 9,5 | 34,0 | |

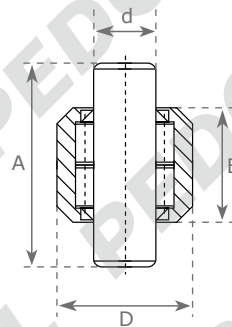
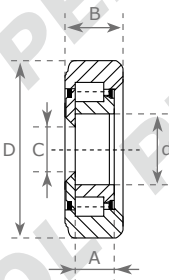

| Codice | App. | d | D | A | B | C |
|--------------|-------|------|------|-------|------|-----|
| 59806 | Linde | 30,0 | 75,1 | 16,25 | 24,0 | M19 |
| 59807 | Linde | 30,0 | 75,6 | 16,25 | 24,0 | |
| 59808 | Linde | 30,0 | 76,1 | 16,25 | 24,0 | |

| Codice | Applicazione | d | D | A | B |
|--------------|--------------|------|------|------|------|
| 59470 | Linde | 22,0 | 48,0 | 72,0 | 40,0 |
| 59471 | Linde | 22,0 | 50,0 | 72,0 | 40,0 |

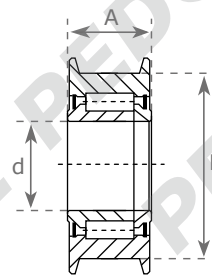
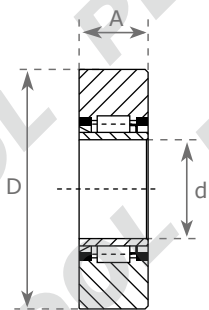

| Codice | Applicazione | d | D | A |
|--------------|--------------|------|-------|------|
| 17189 | Linde | 45,0 | 115,0 | 32,0 |

| Codice | Applicazione | d | D | A |
|--------------|--------------|------|-------|------|
| 17188 | Linde | 60,0 | 120,0 | 60,0 |

Quote espresse in mm

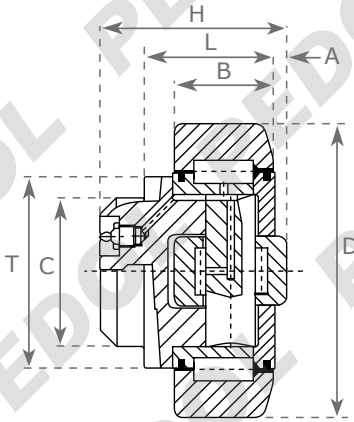

| Codice | App. | A | B | C | D | H | L | T |
|--------------|-------|-----|------|------|-------|------|------|------|
| 59502 | Lugli | 2,0 | 31,0 | 45,0 | 89,3 | 52,0 | 37,0 | 59,0 |
| 59503 | Lugli | 3,0 | 31,0 | 55,0 | 108,5 | 53,0 | 37,0 | 71,0 |
| 59504 | Lugli | 3,0 | 33,0 | 60,0 | 129,4 | 56,5 | 39,5 | 78,0 |

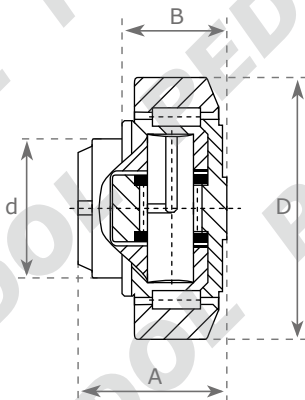

| Codice | Applicazione | d | D | A | B |
|--------------|--------------|------|-------|------|------|
| 59520 | Elecar | 30,0 | 62,0 | 37,5 | 30,5 |
| 59521 | Elecar | 35,0 | 70,1 | 44,0 | 36,0 |
| 59522 | Elecar | 35,0 | 70,45 | 40,5 | 30,5 |
| 59523 | Elecar | 40,0 | 77,7 | 48,0 | 36,5 |
| 59524 | Elecar | 40,0 | 78,3 | 40,7 | 29,0 |
| 59525 | Elecar | 45,0 | 88,9 | 57,0 | 44,0 |
| 59526 | Elecar | 50,0 | 101,9 | 46,0 | 33,0 |
| 59527 | Elecar | 60,0 | 107,7 | 69,0 | 55,0 |
| 59528 | Elecar | 55,0 | 108,5 | 53,0 | 39,0 |
| 59529 | Elecar | 60,0 | 123,1 | 72,3 | 56,0 |
| 59530 | Elecar | 55,0 | 123,5 | 57,0 | 42,0 |
| 59531 | Elecar | 60,0 | 123,8 | 72,3 | 56,0 |
| 59532 | Elecar | 60,0 | 149,7 | 78,5 | 58,5 |
| 59533 | Elecar | 80,0 | 165,0 | 61,0 | 46,0 |

Quote espresse in mm

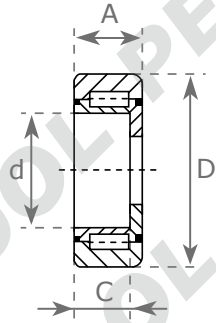

| Codice | Applicazione | d | D | A | C |
|--------------|--------------|------|-------|------|------|
| 59534 | Elecar | 38,0 | 62,0 | 20,0 | 18,0 |
| 59535 | Elecar | 42,0 | 70,1 | 23,0 | 21,0 |
| 59536 | Elecar | 42,0 | 70,45 | 23,0 | 21,0 |
| 59537 | Elecar | 46,0 | 77,7 | 23,0 | 21,0 |
| 59538 | Elecar | 46,0 | 78,3 | 23,0 | 21,0 |
| 59539 | Elecar | 50,0 | 88,9 | 30,0 | 26,0 |
| 59540 | Elecar | 58,0 | 101,9 | 28,0 | 23,5 |
| 59541 | Elecar | 63,0 | 107,7 | 31,0 | 27,5 |
| 59542 | Elecar | 63,0 | 108,5 | 31,0 | 27,5 |
| 59543 | Elecar | 71,0 | 123,1 | 37,0 | 32,5 |
| 59544 | Elecar | 71,0 | 123,8 | 37,0 | 32,5 |
| 59545 | Elecar | 90,0 | 149,7 | 43,0 | 38,0 |
| 59546 | Elecar | 90,0 | 165,0 | 36,0 | 31,0 |

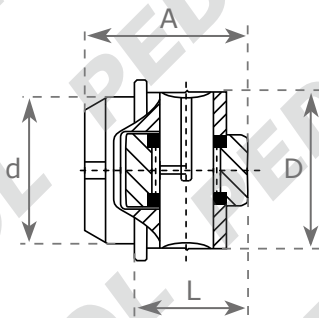

| Codice | Applicazione | d | D | A | L |
|--------------|--------------|------|------|------|------|
| 59547 | Elecar | 30,0 | 38,0 | 37,5 | 30,5 |
| 59548 | Elecar | 35,0 | 42,0 | 44,0 | 36,0 |
| 59549 | Elecar | 35,0 | 42,0 | 40,5 | 30,5 |
| 59560 | Elecar | 40,0 | 46,0 | 48,0 | 36,5 |
| 59561 | Elecar | 40,0 | 46,0 | 40,7 | 29,0 |
| 59562 | Elecar | 45,0 | 50,0 | 57,0 | 44,0 |
| 59563 | Elecar | 50,0 | 58,0 | 50,0 | 33,0 |
| 59564 | Elecar | 60,0 | 63,0 | 69,0 | 55,0 |
| 59565 | Elecar | 55,0 | 63,0 | 53,0 | 39,0 |
| 59566 | Elecar | 60,0 | 71,0 | 72,3 | 56,0 |
| 59567 | Elecar | 60,0 | 90,0 | 78,5 | 58,5 |
| 59568 | Elecar | 80,0 | 90,0 | 61,0 | 46,0 |

Quote espresse in mm

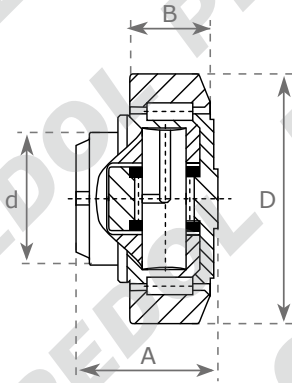

| Codice | Applicazione | d | D | A | B |
|--------------|--------------|------|-------|------|------|
| 59570 | Elecar | 30,0 | 62,0 | 43,0 | 20,0 |
| 59571 | Elecar | 35,0 | 70,1 | 48,0 | 23,0 |
| 59572 | Elecar | 40,0 | 77,7 | 50,5 | 23,0 |
| 59573 | Elecar | 40,0 | 78,3 | 45,0 | 23,0 |
| 59574 | Elecar | 45,0 | 88,9 | 61,0 | 30,0 |
| 59576 | Elecar | 60,0 | 107,7 | 69,0 | 31,0 |
| 59577 | Elecar | 55,0 | 108,5 | 58,5 | 31,0 |
| 59578 | Elecar | 60,0 | 123,0 | 75,8 | 37,0 |
| 59579 | Elecar | 55,0 | 123,5 | 58,0 | 33,0 |
| 59580 | Elecar | 60,0 | 149,0 | 89,0 | 45,0 |

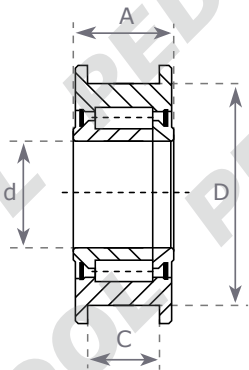

| Codice | Applicazione | d | D | A | C |
|--------------|--------------|------|-------|------|------|
| 59582 | Elecar | 40,0 | 70,0 | 26,5 | 19,0 |
| 59583 | Elecar | 40,0 | 80,0 | 28,0 | 19,0 |
| 59584 | Elecar | 40,0 | 85,0 | 38,0 | 28,0 |
| 59585 | Elecar | 40,0 | 80,0 | 43,0 | 33,0 |
| 59586 | Elecar | 50,0 | 100,0 | 42,0 | 33,0 |
| 59588 | Elecar | 55,0 | 110,0 | 58,0 | 45,0 |
| 59589 | Elecar | 55,0 | 130,0 | 67,0 | 55,0 |

Quote espresse in mm

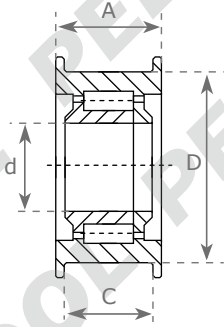

| Codice | App. | d | D | A | C |
|--------------|--------|-------|-------|-------|------|
| 59592 | Elecar | 80,0 | 157,0 | 88,0 | 72,0 |
| 59593 | Elecar | 100,0 | 184,0 | 106,0 | 88,0 |
| 59594 | Elecar | 110,0 | 212,0 | 120,0 | 98,0 |
| 59595 | Elecar | 110,0 | 212,0 | 150,0 | 128 |

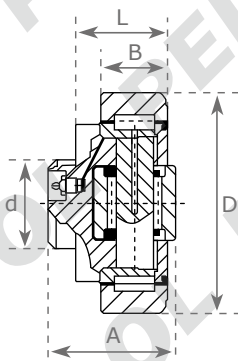

| Codice | App. | d | D | A | B | L |
|--------------|--------|-------|-------|-------|------|------|
| 59601 | Elecar | 60,0 | 129,4 | 56,5 | 33,0 | 39,5 |
| 59602 | Elecar | 60,0 | 160,0 | 78,5 | 43,0 | 58,5 |
| 59603 | Elecar | 100,0 | 190,0 | 84,5 | 48,0 | 64,5 |
| 59604 | Elecar | 110,0 | 220,0 | 94,5 | 58,0 | 74,5 |
| 59605 | Elecar | 120,0 | 250,0 | 102,0 | 60,0 | 77,0 |
| 59606 | Elecar | 150,0 | 280,0 | 109,5 | 64,0 | 89,5 |

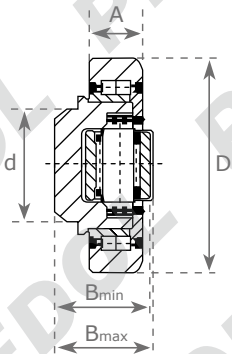

| Codice | App. | d | D | A | B min | B max |
|--------------|--------|-------|-------|------|-------|-------|
| 59607 | Elecar | 55,0 | 123,5 | 33,0 | 57,0 | 59,0 |
| 59608 | Elecar | 80,0 | 165,0 | 40,0 | 69,0 | 72,0 |
| 59609 | Elecar | 100,0 | 190,0 | 48,0 | 84,5 | 87,5 |
| 59610 | Elecar | 110,0 | 220,0 | 58,0 | 94,5 | 97,5 |
| 59611 | Elecar | 120,0 | 250,0 | 60,0 | 102,0 | 105,0 |
| 59612 | Elecar | 150,0 | 280,0 | 72,0 | 119,5 | 123,5 |

Quote espresse in mm

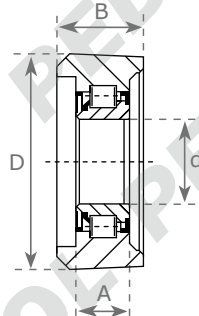

| Codice | Applicazione | d | D | A | B |
|--------------|--------------|------|-------|------|------|
| 60142 | Om | 20,0 | 62,2 | 15,0 | 28,5 |
| 59700 | Om | 28,0 | 75,2 | 18,0 | 35,0 |
| 60070 | Om | 28,0 | 77,2 | 18,0 | 27,0 |
| 60229 | Om* | 35,0 | 88,2 | 21,0 | 30,0 |
| 60324 | Om | 35,0 | 88,2 | 21,0 | 30,0 |
| 59701 | Om | 35,0 | 88,2 | 24,0 | 37,0 |
| 59702 | Om | 40,0 | 101,2 | 25,0 | 40,0 |

* Rinforzato

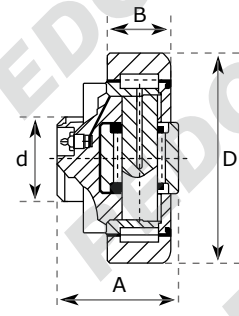
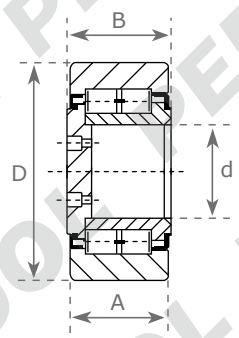

| Codice | Applicazione | d | D | A | B |
|--------------|--------------|------|-------|------|------|
| 59704 | Om | 55,0 | 124,0 | 42,0 | 46,0 |

| Codice | Applicazione | d | D | A | B |
|--------------|--------------|------|-------|------|------|
| 59705 | Om | 40,0 | 77,0 | 48,0 | 26,5 |
| 59706 | Om | 45,0 | 88,4 | 57,0 | 30,0 |
| 59707 | Om | 60,0 | 107,5 | 69,0 | 36,0 |

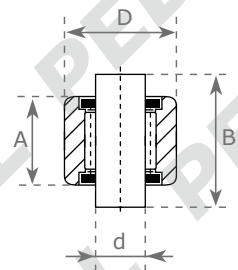
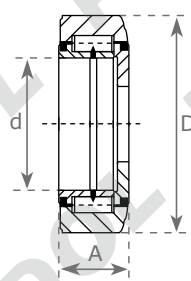

| Codice | Applicazione | d | D | A |
|--------------|--------------|------|------|------|
| 59709 | Om | 45,7 | 77,7 | 26,5 |
| 59710 | Om | 46,8 | 88,4 | 31,0 |

| Codice | Applicazione | d | D | A | B |
|--------------|--------------|------|------|------|------|
| 59712 | Om | 13,5 | 34,0 | 18,0 | 43,0 |
| 59713 | Om | 15,3 | 36,0 | 20,0 | 46,5 |

Quote espresse in mm

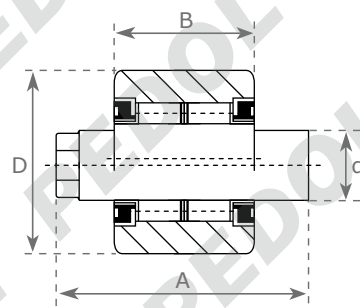
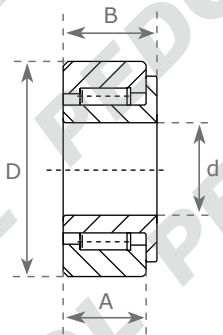

| Codice | Applicazione | d | D | A | B |
|--------------|--------------|------|-------|------|------|
| 59715 | Om | 70,0 | 120,0 | 38,0 | 45,0 |

| Codice | Applicazione | d | D | A | B |
|--------------|--------------|------|------|-------|------|
| 59716 | Om | 20,0 | 55,0 | 100,0 | 50,0 |

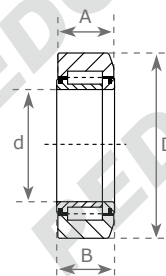
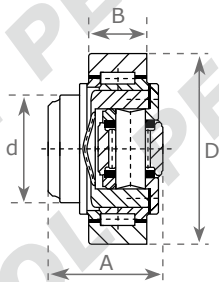

| Codice | Applicazione | d | D | A | B |
|--------------|--------------|------|-------|------|------|
| 59717 | Om | 60,0 | 107,5 | 69,0 | 36,0 |
| 59718 | Om | 60,0 | 123,0 | 72,0 | 37,0 |
| 59719 | Om | 60,0 | 149,0 | 77,0 | 45,0 |

| Codice | Applicazione | d | D | A | B |
|--------------|--------------|------|-------|------|------|
| 59725 | Om | 60,0 | 107,5 | 36,0 | 37,0 |
| 59726 | Om | 65,0 | 123,0 | 37,0 | 37,0 |
| 59727 | Om | 82,0 | 149,0 | 45,0 | 46,0 |
| 59734 | Om | 65,0 | 123,0 | 38,0 | 37,0 |

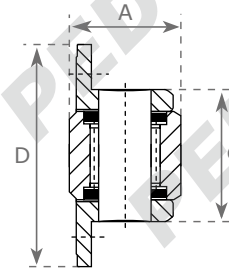
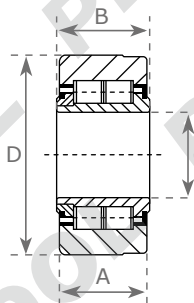

| Codice | Applicazione | d | D | A | B |
|--------------|--------------|------|-------|------|------|
| 59728 | Om | 65,0 | 124,2 | 37,0 | 40,0 |
| 59729 | Om | 95,0 | 185,0 | 47,0 | 48,0 |

| Codice | Applicazione | d | D | A |
|--------------|--------------|------|-------|------|
| 59730 | Om | 45,0 | 73,0 | 36,0 |
| 59733 | Om | 72,0 | 105,0 | 55,0 |

Quote espresse in mm

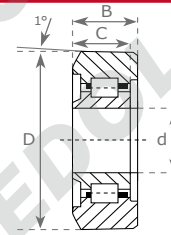
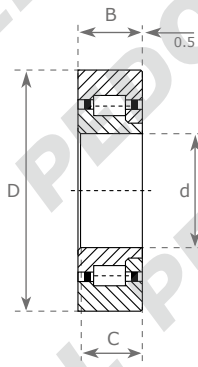

| Codice | Applicazione | d | D | C | B |
|--------------|--------------|------|------|------|------|
| 57845 | Jungheinrich | 30,0 | 62,0 | 16,1 | 16,0 |
| 57652 | Jungheinrich | 50,0 | 90,0 | 18,5 | 20,0 |

| Codice | Applicazione | d | D | C | B |
|--------------|--------------|------|------|------|------|
| 68106 | Jungheinrich | 28,0 | 75,3 | 21,0 | 25,0 |
| 68097 | Jungheinrich | 28,0 | 75,9 | 21,0 | 26,0 |
| 68098 | Jungheinrich | 28,0 | 76,4 | 21,0 | 26,0 |
| 68104 | Jungheinrich | 28,0 | 78,5 | 21,0 | 24,5 |
| 68105 | Jungheinrich | 28,0 | 79,9 | 21,0 | 24,0 |
| 68182 | Jungheinrich | 35,0 | 96,5 | 30,0 | 33,0 |

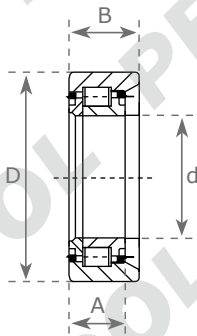

| Codice | Applicazione | d | D | A | B |
|--------------|--------------|------|-------|------|------|
| 59650 | Pgs-Lte | 35,0 | 60,5 | 17,2 | 20,0 |
| 59651 | Pgs-Lte | 45,0 | 73,4 | 17,2 | 21,0 |
| 59652 | Pgs-Lte | 45,0 | 80,5 | 17,0 | 23,0 |
| 59653 | Pgs-Lte | 55,0 | 100,5 | 24,0 | 28,0 |
| 59655 | Pgs-Lte | 65,0 | 120,0 | 23,0 | 33,0 |
| 59656 | Pgs-Lte | 65,0 | 130,4 | 25,0 | 29,0 |

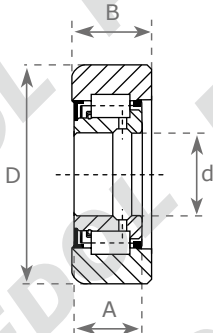

| Codice | Applicazione | d | D | A | B |
|--------------|--------------|------|------|------|------|
| 59770 | Steinbock | 35,0 | 83,5 | 29,5 | 33,0 |
| 59771 | Steinbock | 35,0 | 84,5 | 29,5 | 33,0 |
| 59773 | Steinbock | 35,0 | 96,5 | 29,5 | 33,0 |
| 59774 | Steinbock | 35,0 | 97,5 | 29,5 | 33,0 |
| 59775 | Steinbock | 35,0 | 98,5 | 29,5 | 33,0 |

Quote espresse in mm

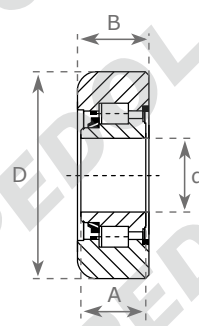
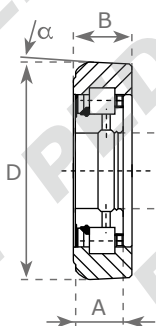

| Codice | App. | d | D | A | B | α |
|--------------|-----------|------|-------|------|------|----------|
| 59776 | Steinbock | 35,0 | 101,5 | 22,5 | 27,0 | 1,5° |
| 59777 | Steinbock | 40,0 | 100,0 | 29,5 | 33,0 | 3,0° |

| Codice | App. | d | D | A | B |
|--------------|-----------|------|------|------|------|
| 59778 | Steinbock | 35,0 | 96,5 | 29,5 | 33,0 |
| 59779 | Steinbock | 35,0 | 97,5 | 29,5 | 33,0 |
| 59780 | Steinbock | 35,0 | 98,5 | 29,5 | 33,0 |

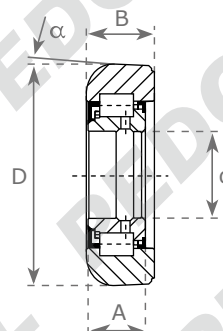
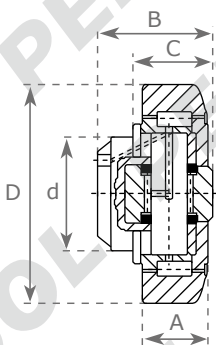

| Codice | App. | d | D | A | B | C |
|--------------|-----------|------|-------|------|------|------|
| 59781 | Steinbock | 40,0 | 77,7 | 23,0 | 40,5 | 29,0 |
| 59783 | Steinbock | 50,0 | 101,2 | 28,0 | 45,7 | 33,0 |

| Codice | App. | d | D | A | B | α |
|--------------|-----------|------|------|------|------|----------|
| 59785 | Steinbock | 30,0 | 76,0 | 19,0 | 23,0 | 1,5° |

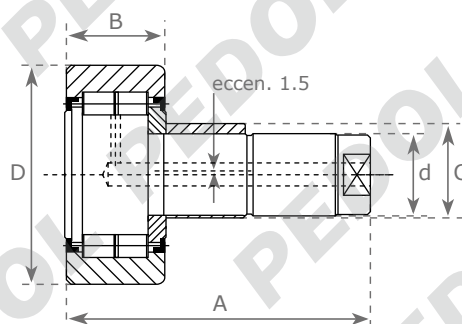
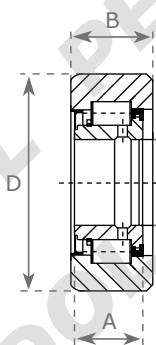

| Codice | Applicazione | d | D | A | B |
|--------------|--------------|------|------|------|------|
| 59786 | Steinbock | 35,0 | 91,2 | 29,5 | 33,0 |

| Codice | App. | d | D | A | B | C |
|--------------|-----------|---------|------|-------|------|------|
| 59790 | Steinbock | M30x1,5 | 80,0 | 112,0 | 35,0 | 35,0 |

Quote espresse in mm

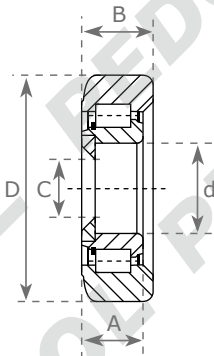

| Codice | App. | d | D | A | B | C |
|--------------|-------|------|-------|-------|------|-----|
| 59800 | Still | 36,0 | 89,8 | 24,10 | 29,0 | M20 |
| 59801 | Still | 36,0 | 90,3 | 24,10 | 29,0 | |
| 59802 | Still | 36,0 | 90,8 | 24,10 | 29,0 | |
| 59803 | Still | 42,0 | 105,2 | 28,75 | 34,0 | M23 |
| 59804 | Still | 42,0 | 105,7 | 28,75 | 34,0 | |
| 59805 | Still | 42,0 | 106,2 | 28,75 | 34,0 | |

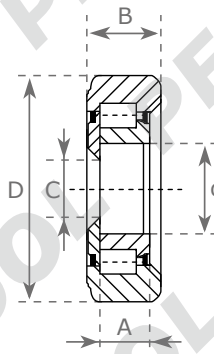

| Codice | App. | d | D | A | B | C |
|--------------|-------|------|------|-------|------|-----|
| 59806 | Still | 30,0 | 75,2 | 16,25 | 24,0 | M19 |
| 59807 | Still | 30,0 | 75,7 | 16,25 | 24,0 | |
| 59808 | Still | 30,0 | 76,2 | 16,25 | 24,0 | |

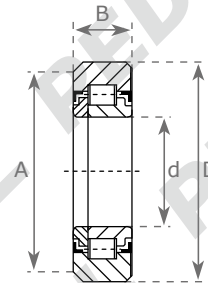
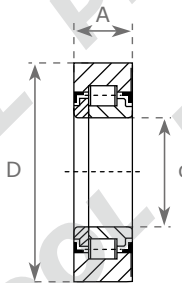

| Codice | Applicazione | d | D | A | B |
|--------------|--------------|------|-------|------|---|
| 59809 | Still | 55,0 | 110,0 | 26,0 | |

| Codice | Applicazione | d | D | A | B |
|--------------|--------------|------|------|------|------|
| 59812 | Still | 45,0 | 90,0 | 80,0 | 23,4 |

Quote espresse in mm

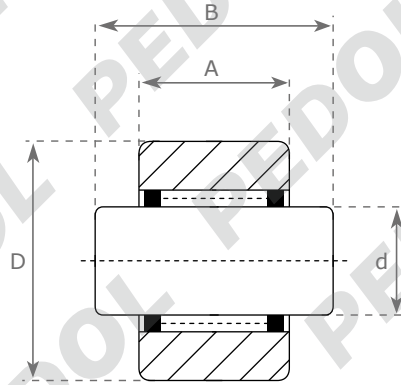
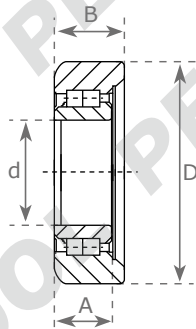

| Codice | Applicazione | d | D | A | B |
|--------------|--------------|------|-------|------|------|
| 59475 | Still | 65,0 | 135,6 | 35,0 | 42,0 |
| 59814 | Still | 45,0 | 105,2 | 27,0 | 34,0 |
| 59815 | Still | 45,0 | 105,7 | 27,0 | 34,0 |
| 59816 | Still | 45,0 | 106,2 | 27,0 | 34,0 |

| Codice | Applicazione | d | D | A | B |
|--------------|--------------|------|------|------|------|
| 59811 | Still | 15,0 | 30,0 | 20,0 | 33,0 |
| 59810 | Still | 18,0 | 40,0 | 24,0 | 41,0 |

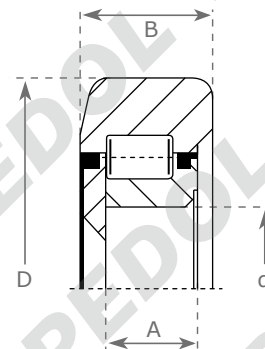
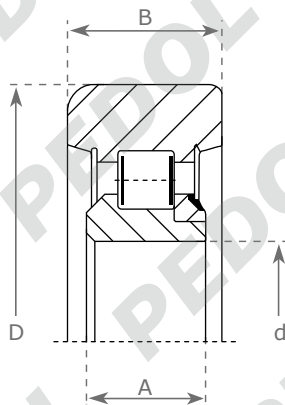

| Codice | Applicazione | d | D | A | B |
|--------------|--------------|------|-------|------|------|
| 59920 | Toyota | 35,0 | 94,5 | 21,0 | 28,0 |
| 59921 | Toyota | 40,0 | 109,7 | 23,0 | 32,0 |
| 59922 | Toyota | 45,0 | 114,5 | 25,0 | 34,0 |
| 59924 | Toyota | 45,0 | 124,5 | 25,0 | 34,0 |
| 59923 | Toyota | 40,0 | 125,0 | 23,0 | 32,0 |

| Codice | Applicazione | d | D | A | B |
|--------------|--------------|------|-------|------|----|
| 59925 | Toyota | 35,0 | 114,5 | 21,0 | 28 |

Quote espresse in mm

PEDOL

www.pedol.com

Fratelli Pedol s.p.a

Sede legale, produzione cabine, marmitte e paraurti

Via Fabbri, 10 - Z.I. Campidui
31015 Conegliano (Treviso)
Tel. +39 0438 450952
Fax +39 0438 450979

info@pedol.com

Sede commerciale Conegliano

Via dell'Industria, 29
31015 Conegliano (Treviso)

Ricambi carrelli elevatori

Tel. +39 0438 411884
Fax +39 0438 411015

Ricambi auto/ elettromeccanica

Tel. +39 0438 32941
Fax +39 0438 411015

Sede commerciale Bellusco

Via Ornago, 27
20040 Bellusco (Milano)

Ricambi carrelli elevatori

Tel. +39 039 6883373
Fax +39 039 6202105